



# 19 Nassim



## Life on Nassim

19 Nassim is the legacy of the internationally-acclaimed and award-winning architect, Soo K. Chan, Principal of SCDA Architects.

His precious creation of only 101 residences marks the start of your life on Nassim – one of the Garden City's most prestigious locales.



# A Prestigious District in the Garden City

## 19 Nassim



Ngee Ann City



8 min.

ION Orchard



9 min.

Marina Bay  
Financial Centre



18 min.

Raffles Place



16 min.

St. Regis Hotel



2 min.

Regent Hotel



6 min.

Tanglin Mall



2 min.

INTERPOL



1 min.

Embassy of the  
People's Republic  
of China



3 min.

British High  
Commission



3 min.

U.S.  
Embassy



4 min.

Australian High  
Commission



5 min.

Singapore  
Botanic Gardens



3 min.

Sentosa



20 min.

Keppel Bay



18 min.

Dempsey Hill



5 min.



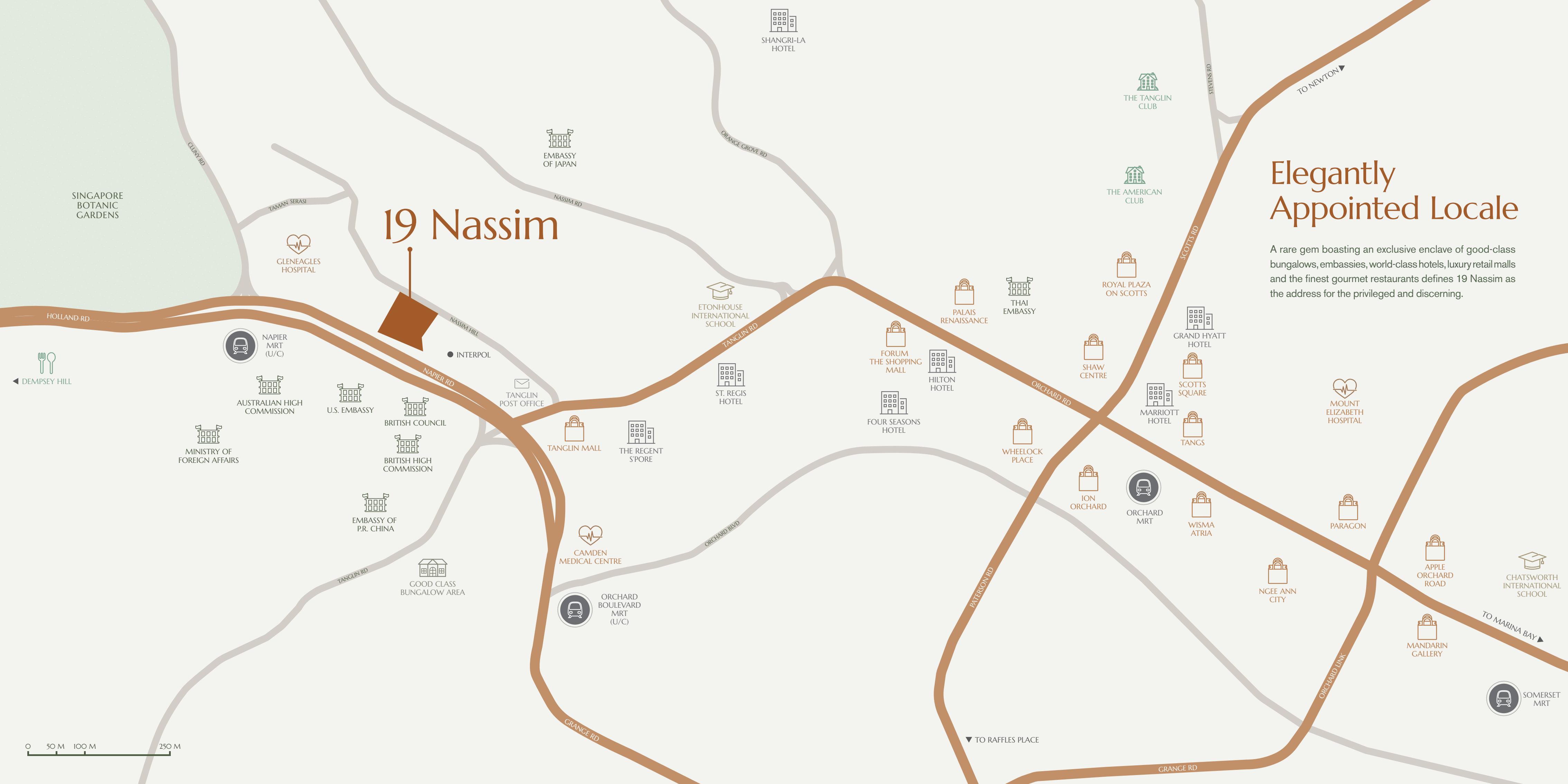

# 19 Nassim

## Elegantly Appointed Locale

A rare gem boasting an exclusive enclave of good-class bungalows, embassies, world-class hotels, luxury retail malls and the finest gourmet restaurants defines 19 Nassim as the address for the privileged and discerning.

0 50 M 100 M 250 M



◀ DEMPSEY HILL



SOMERSET MRT

TO MARINA BAY ▶

CHATSWORTH INTERNATIONAL SCHOOL

APPLE ORCHARD ROAD

MANDARIN GALLERY

PARAGON

NGEE ANN CITY

WISMA ATRIA

ORCHARD MRT

ION ORCHARD

WHELLOCK PLACE

HILTON HOTEL

FORUM THE SHOPPING MALL

FOUR SEASONS HOTEL

ST. REGIS HOTEL

ETONHOUSE INTERNATIONAL SCHOOL

THE REGENT S'PORE

TANGLIN MALL

TANGLIN POST OFFICE

● INTERPOL

EMBASSY OF P.R. CHINA

BRITISH HIGH COMMISSION

U.S. EMBASSY

BRITISH COUNCIL

AUSTRALIAN HIGH COMMISSION

MINISTRY OF FOREIGN AFFAIRS

NAPIER MRT (U/C)

GLENEAGLES HOSPITAL

MOUNT ELIZABETH HOSPITAL

MARRIOTT HOTEL

GRAND HYATT HOTEL

SCOTT'S SQUARE

ROYAL PLAZA ON SCOTTS

THE AMERICAN CLUB

THE TANGLIN CLUB

THE TANGLIN CLUB

SHANGRI-LA HOTEL

EMBASSY OF JAPAN

SINGAPORE BOTANIC GARDENS

HOLLAND RD

CLUNY RD

TAMAN SERASI

NASSIM RD

ORANGE GROVE RD

STEVENS RD

TO NEWTON ▶

NASSIM HILL

NAPIER RD

TANGLIN RD

ORCHARD RD

SCOTTS RD

ORCHARD BVD

TANGLIN RD

PATERSON RD

ORCHARD LINK

GRANGE RD

▼ TO RAFFLES PLACE

GRANGE RD



## A Treasured World Heritage Site is Your Back Garden

Teeming with natural flora and fauna, the iconic Singapore Botanic Gardens, a UNESCO World Heritage Site, is an 82-hectare tropical paradise and a haven for the senses. Residents of 19 Nassim can enjoy one of the most loved tropical gardens on Earth as their very own.







# Become One with Nature

From the first glimmer of sunlight at dawn to the gentle fade of dusk, the Singapore Botanic Gardens simply captivates. Enjoy a picnic or concerts by the Shaw Symphony Stage or breathe in fresh air while strolling through the nature wonderlands of Orchid Gardens, Keppel Discovery Wetlands or the Botanists' Boardwalk and uncover a wealth of tropical treasures that guarantee a soothing experience.





## Bespoke Brands and Michelin-Starred Restaurants Abound

Orchard Road's breathtaking array of mega shopping malls ensure that you can always surround yourself with the bustle desired. Peppered with the latest names in high fashion, bespoke luxe brands and Michelin-Starred restaurants, this world-class lifestyle precinct will always leave you with something to enjoy. After all, a five-minute stroll is all it takes for you to reach the heart and buzz of Singapore.







## The City's Coolest Enclave

Dine out in style at Dempsey Hill which is located just a five-minute drive away from 19 Nassim. It's time to chill with Singapore's cosmopolitan community at hip art galleries, upmarket boutiques and chic cocktail bars. Also, there's always something for the family – think trendy restaurants, enchanting bistros and a smorgasbord of delightful delicatessens.







## The Maestro's Latest Masterpiece

19 Nassim is a trophy boutique residence. With selected screens cleverly-designed against full-height windows, astounding views can be enjoyed in absolute privacy, while elegantly-detailed facades shape this work of architectural art.





Artist's Impression

## Mark Your Arrival

A journey of sensory pleasure unfolds as you enter The Lobby. Here, nature and architecture blend together harmoniously. Be mesmerised as the gentle cascading steps pave the way to a lush, landscaped pool deck, revealing the stunning Garden Lounge and infinity Lap Pool.



## Spaces with Natural Style

The pool deck, a calming composition of water and clean lines, is elegantly framed by raw hues of granite and a timeless palette of light greys and verdant greens. The Pool Cabanas and The Gym blend the tranquility of the infinity Lap Pool with the vibrancy of the Kids' Pool in an arrangement of refined leisure amenities.



Artist's Impression





Artist's Impression

## Elevated Living Above & Beyond

Opening up to the rooftop lounge overlooking a manicured lawn, a state-of-the-art kitchen by leading European appliance brands sets the perfect scene for intimate gourmet dining functions in The Club. Host your party under the stars at The Grill and be mesmerised by expansive city views.





Artist's Impression

## Soak in Splendour and Sophistication

A Relaxation Pool at the Club Level offers panoramic views of the surrounding Nassim enclave against the Garden City's skyline. This private haven, with a heated Jet pool, guarantees ultimate relaxation day or night.



## Homes Designed with Soul

With its minimalist, contemporary tropical architecture set within a natural landscape for intimate garden living, 19 Nassim beautifully blends the boundaries between indoors and outdoors. The one-to three-bedroom apartments are thoughtfully designed with a practical and functional layout. Selected two-bedroom and all three-bedroom apartments have access to private lift lobbies, with a selection of three-bedroom apartments boasting generous double volume space which allows natural light into a large living area.



Artist's Impression





Artist's Impression

# The Finest Names in the World's Best Homes

Enjoy a curated collection of kitchen appliances favoured by Michelin-Starred restaurants around the world, as well as bathware and fittings preferred by the world's top interior designers for luxury hotels, right within your own home.



**V-ZUG**  
V-Zug integrates innovative technology and smart cooking features into its kitchen appliances and is renowned for its premium quality, high precision and intelligent living.



**DORNBRACHT**  
A German brand of high-quality sanitary fittings has established a reputation for excellence.



**VILLEROY & BOCH**  
Through its high-quality and innovative bathware, Villeroy & Boch has brought style and sophistication into people's homes.





# Even Smarter Homes

19 Nassim is the first residential development in Singapore designed to be powered by Artificial Intelligence (A.I.). The first-of-its-kind smart home management system allows homeowners to smoothly control in-house devices and facilitates quick access to community and lifestyle services via the most popular messaging apps such as WhatsApp and WeChat to create an effortlessly comfortable and smart lifestyle. The A.I. will progressively learn your habits & daily routines, offering useful suggestions to improve your smart living experience.



### SMART HOME CONTROLS

Control connected devices from wherever, whenever

- Smart Door Lock
- Smart Aircon
- Smart Heater
- Smart Smoke Alarm
- Smart Intercom System



### SMART COMMUNITY MANAGEMENT

Combine convenience with comfort

- Common Area Facility Booking
- Smart Function Room, BBQ Pit and Gym
- Visitor Invitation System with QR Code
- Smart Parcel Box
- Keyless Letter Box



### SMART LIFESTYLE GATEWAY

A plethora of services at your reach

- Home Furnishings
- Groceries
- Dining
- Fashion & Beauty
- Transportation



## Life is Beautiful on Nassim

A suite of bespoke services has been exclusively arranged for residents of 19 Nassim. From curated events to catering to your everyday needs, your Resident Host is always delighted to serve you.



Artist's Impression



# Level 1 – Lobby Level



# Level 10 – Club Level



## LEGEND

### Lobby Level

- 1 The Arrival
- 2 Reflective Pool
- 3 The Lobby
- 4 Lobby Garden
- 5 The Pond
- 6 Grand Staircase
- 7 Garden Lounge
- 8 Feature Pool
- 9 Pool Cabanas
- 10 Lap Pool
- 11 Kids' Pool
- 12 The Gym
- 13 Relaxation Corner
- 14 Changing Room
- 15 Pebble Walk
- 16 Kids' Playground

### Club Level

- 17 Relaxation Pool
- 18 Heated Jet Pool
- 19 Sun Deck
- 20 The Grill
- 21 The Terrace
- 22 The Lounge
- 23 The Club
- 24 Changing Room

### Ancillary

- A Guardhouse
- B Bin Centre
- C Substation
- D Pedestrian Gate at Nassim Hill
- E Pedestrian Gate at Napier Road
- F Service Gate
- G M&E Room
- H Green Roof (not accessible)

0 5 10 20 30M

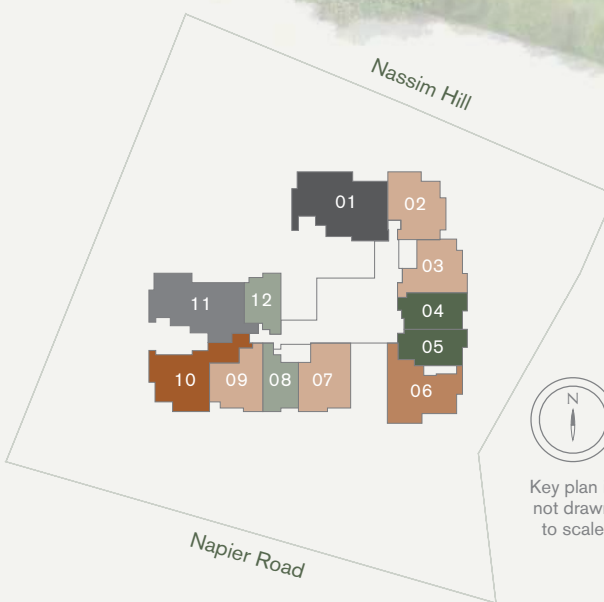



# Unit Distribution Diagram

Unit No.	01	02	03	04	05	06	07	08	09	10	11	12	
Level													
10	CLUB LEVEL						M&E	GREEN ROOF	C3	C2	A1		
9	C1	B1	B2	AS1	AS2	BS1	B3	A2	B2A	B4	C2	A1	
8	D1	B1	B2	AS1	AS2	BS1	B3	A2	B2A	B4	C2	A1	
7	C1	B1	B2	AS1	AS2	BS1	B3	A2	B2A	B4	C2	A1	
6	D1	B1	B2	AS1	AS2	BS1	B3	A2	B2A	B4	C2	A1	
5	C1	B1	B2	AS1	AS2	BS1	B3	A2	B2A	B4	C2	A1	
4	D1	B1	B2	AS1	AS2	BS1	B3	A2	B2A	B4	C2	A1	
3	C1	B1	B2	AS1	AS2	BS1	B3	A2	B2A	B4	C2	A1	
2	D1	B1	B2	AS1	AS2	BS1	B3	A2	B2A	B4	C2	A1	
1	D1(P)	B1(P)	LOBBY LEVEL										
	POOL LEVEL												

1-Bedroom
  1-Bedroom + Study
  2-Bedroom
  2-Bedroom + Study
  2-Bedroom Deluxe
  3-Bedroom Deluxe

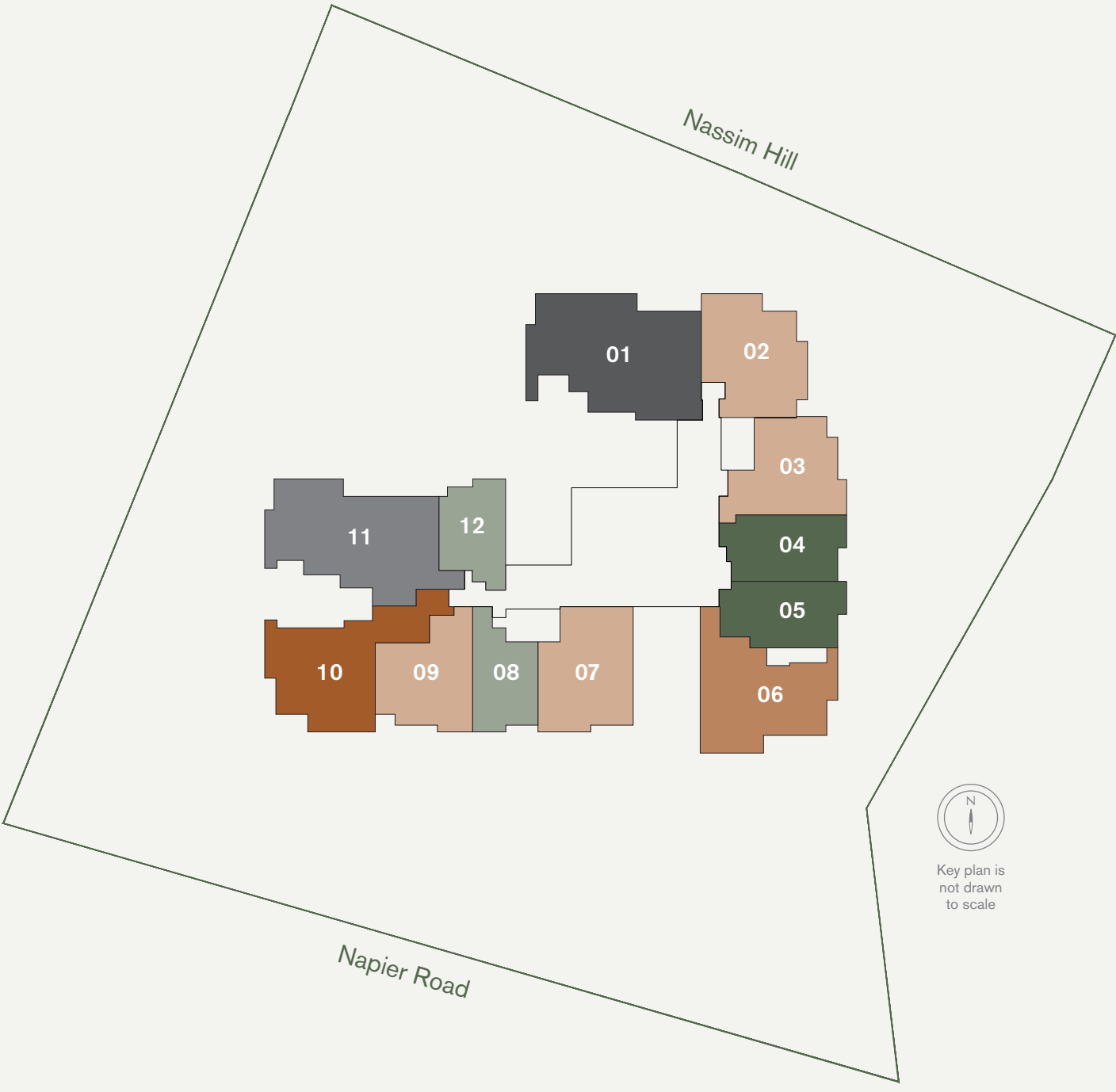



# 1-Bedroom

## Type A1

50 sqm / 538 sq ft  
#02-12 to #08-12, #09-12\*, #10-12\*

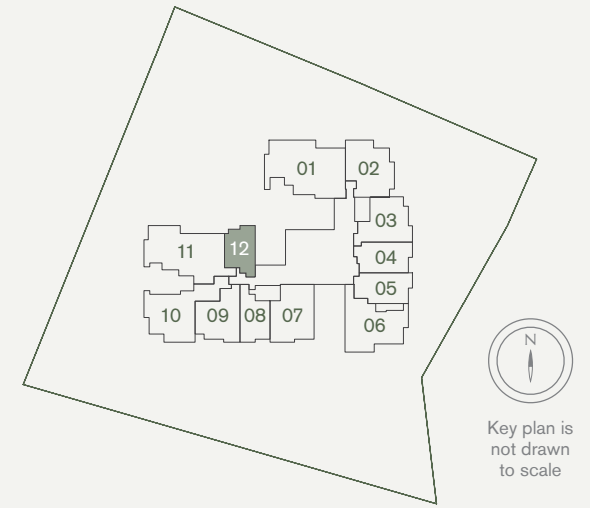

ODD FLOOR

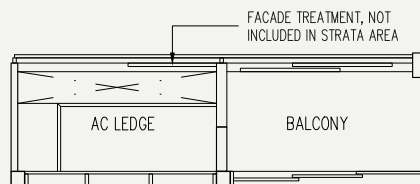

EVEN FLOOR

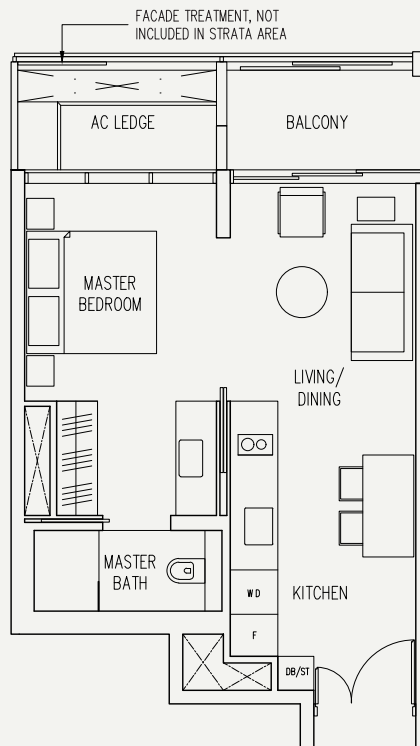

Area includes air-con (A/C) ledge, balcony and strata void area where applicable. Please refer to the key plan for orientation. The plans are subject to change as may be approved by relevant authorities. All floor plans are approximate measurements only and are subject to government re-survey. The balcony shall not be enclosed unless with the approved balcony screen. \*Denotes different ceiling height.



# 1-Bedroom

## Type A2

53 sqm / 570 sq ft  
#02-08 to #08-08, #09-08\*

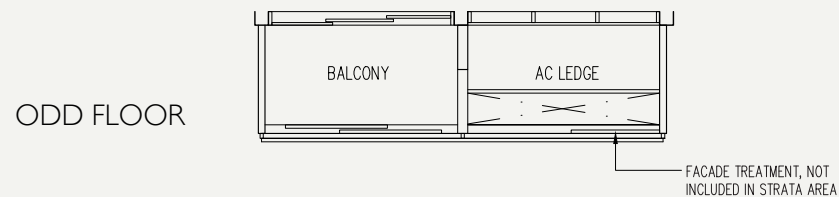
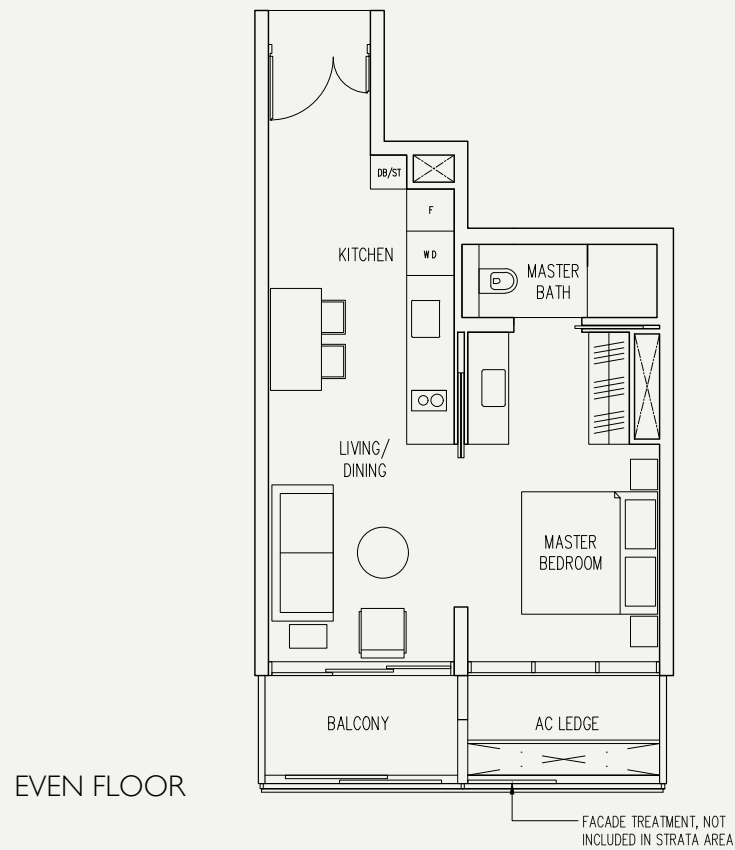
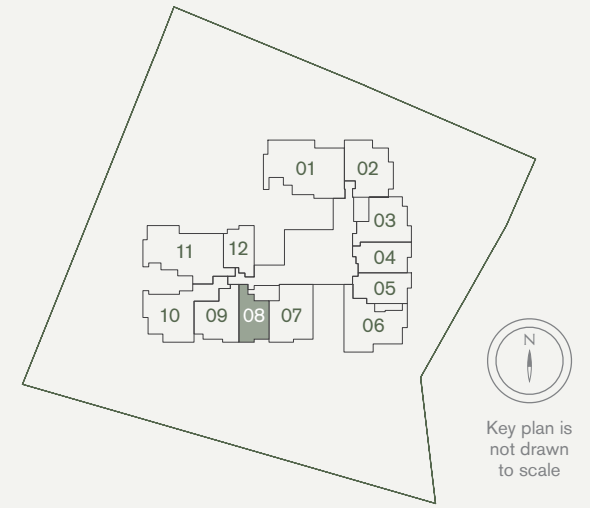

Area includes air-con (A/C) ledge, balcony and strata void area where applicable. Please refer to the key plan for orientation. The plans are subject to change as may be approved by relevant authorities. All floor plans are approximate measurements only and are subject to government re-survey. The balcony shall not be enclosed unless with the approved balcony screen. \*Denotes different ceiling height.



# 1-Bedroom + Study

Type AS1

63 sqm / 678 sq ft  
#02-04 to #09-04

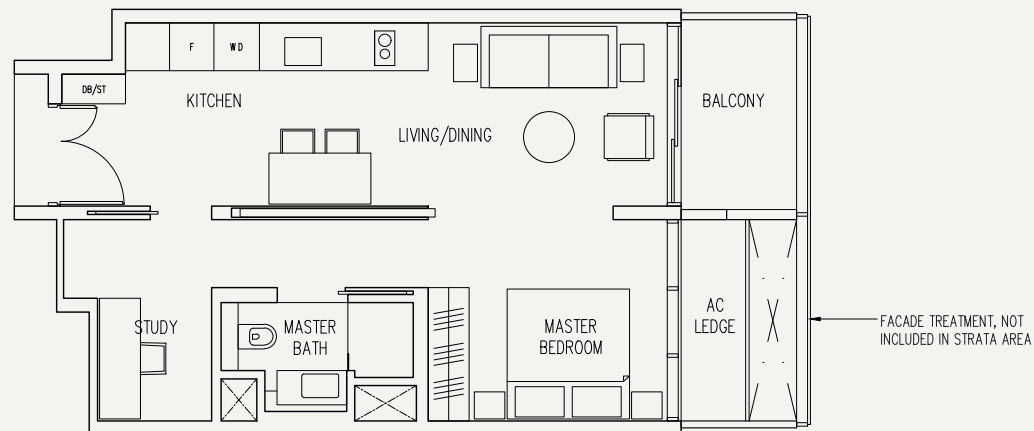
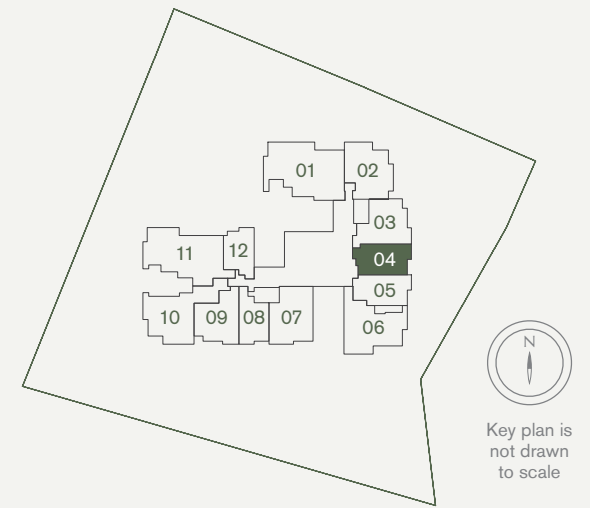

Area includes air-con (A/C) ledge, balcony and strata void area where applicable. Please refer to the key plan for orientation. The plans are subject to change as may be approved by relevant authorities. All floor plans are approximate measurements only and are subject to government re-survey. The balcony shall not be enclosed unless with the approved balcony screen. \*Denotes different ceiling height.



# 1-Bedroom + Study

Type AS2

60 sqm / 646 sq ft  
#02-05 to #09-05

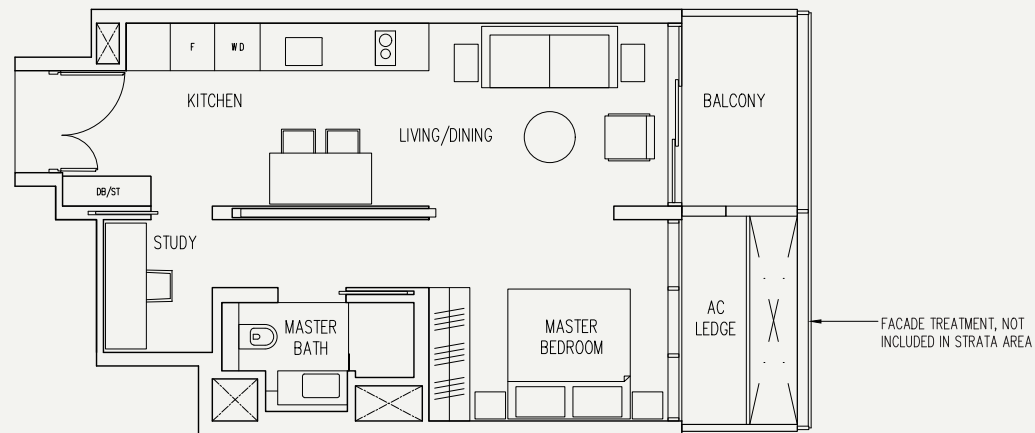
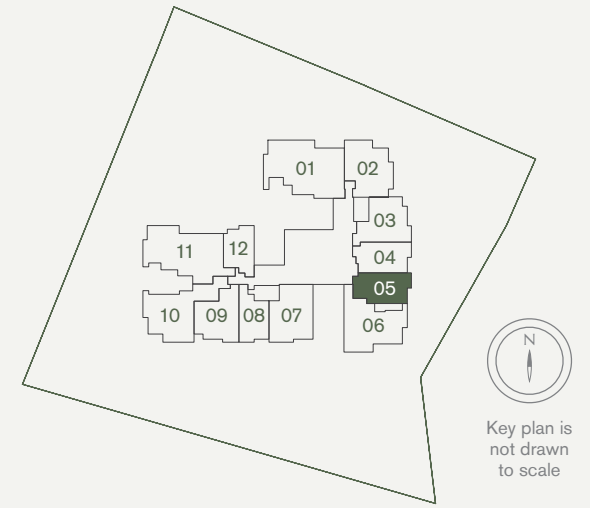

Area includes air-con (A/C) ledge, balcony and strata void area where applicable. Please refer to the key plan for orientation. The plans are subject to change as may be approved by relevant authorities. All floor plans are approximate measurements only and are subject to government re-survey. The balcony shall not be enclosed unless with the approved balcony screen. \*Denotes different ceiling height.



# 2-Bedroom

Type B1(P)

104 sqm / 1,119 sq ft  
#01-02

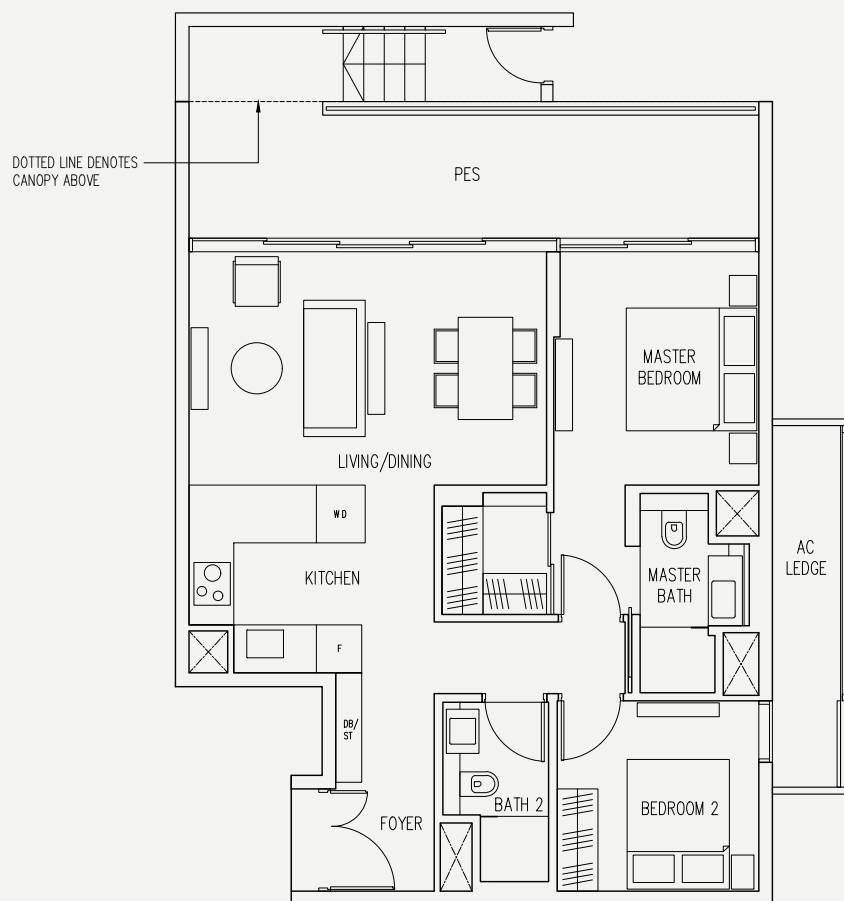
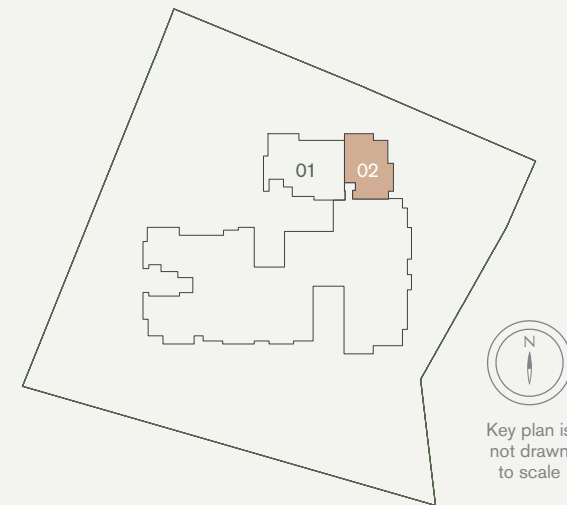

Area includes air-con (A/C) ledge, balcony and strata void area where applicable. Please refer to the key plan for orientation. The plans are subject to change as may be approved by relevant authorities. All floor plans are approximate measurements only and are subject to government re-survey. \*Denotes different ceiling height.



# 2-Bedroom

## Type B1

90 sqm / 969 sq ft  
#02-02 to #08-02, #09-02\*

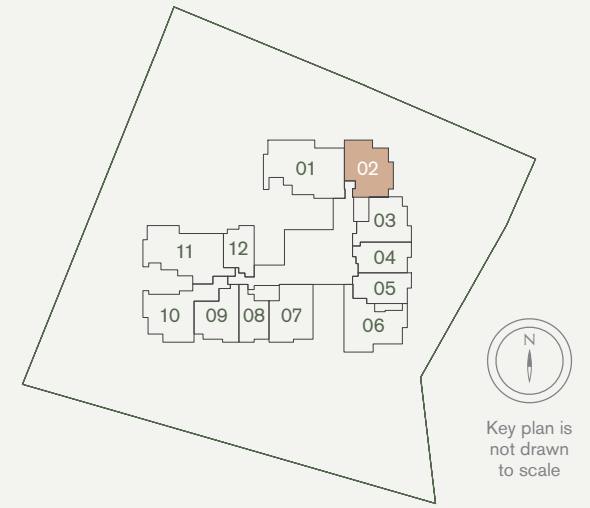

ODD FLOOR

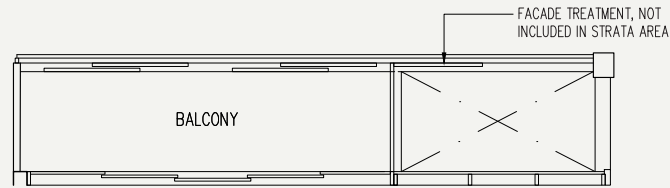

EVEN FLOOR

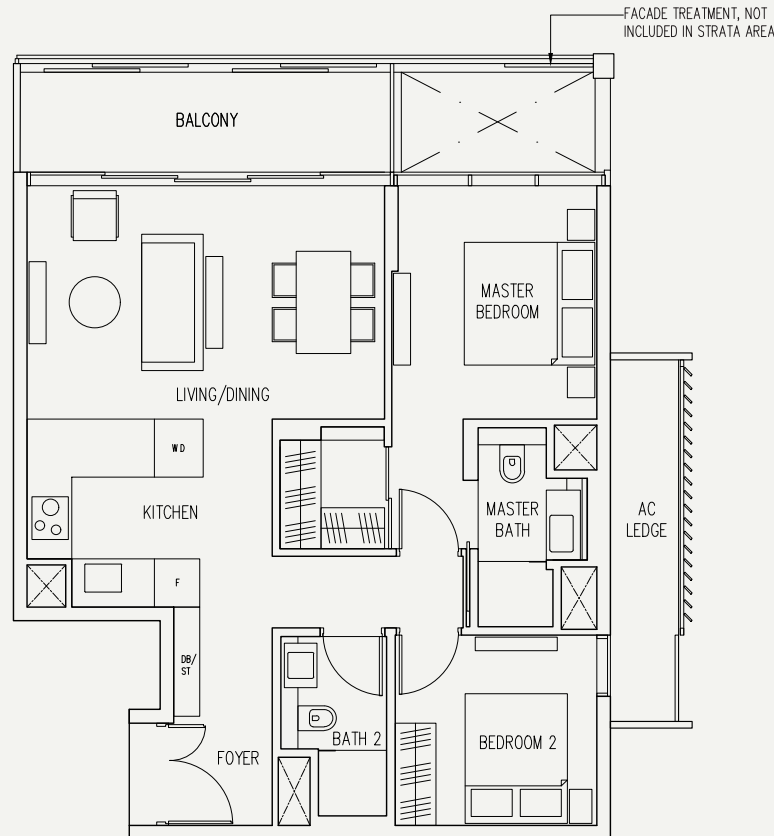

Area includes air-con (A/C) ledge, balcony and strata void area where applicable. Please refer to the key plan for orientation. The plans are subject to change as may be approved by relevant authorities. All floor plans are approximate measurements only and are subject to government re-survey. The balcony shall not be enclosed unless with the approved balcony screen. \*Denotes different ceiling height.



# 2-Bedroom

## Type B2

77 sqm / 829 sq ft  
#02-03 to #09-03

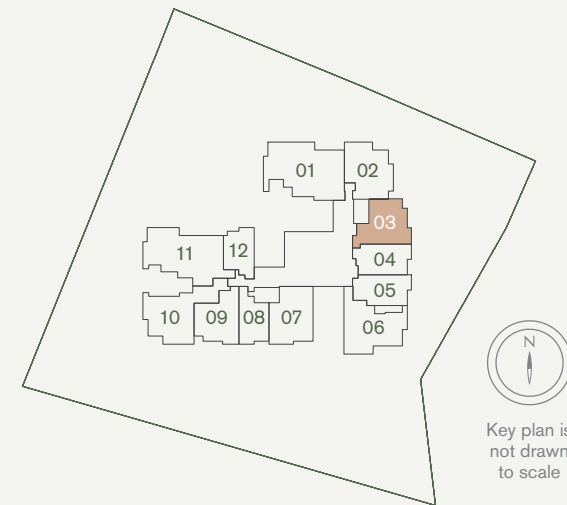

Key plan is not drawn to scale

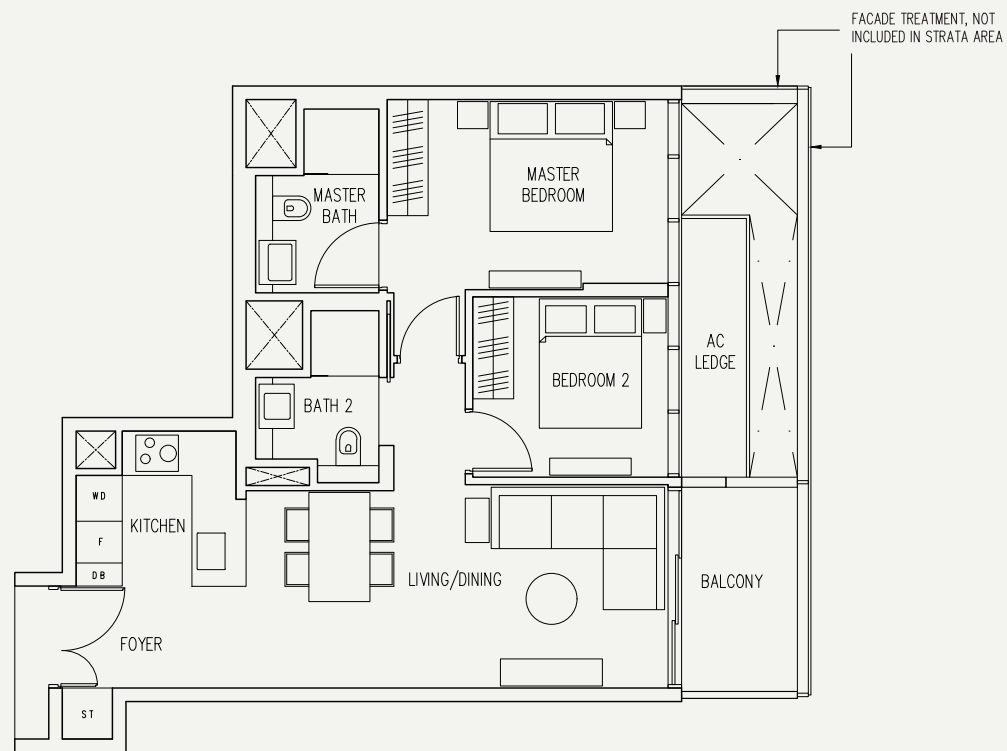

Area includes air-con (A/C) ledge, balcony and strata void area where applicable. Please refer to the key plan for orientation. The plans are subject to change as may be approved by relevant authorities. All floor plans are approximate measurements only and are subject to government re-survey. The balcony shall not be enclosed unless with the approved balcony screen. \*Denotes different ceiling height.



# 2-Bedroom

## Type B2A

75 sqm / 807 sq ft  
#02-09 to #08-09, #09-09\*

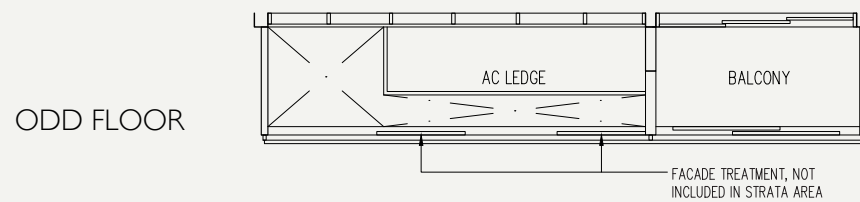
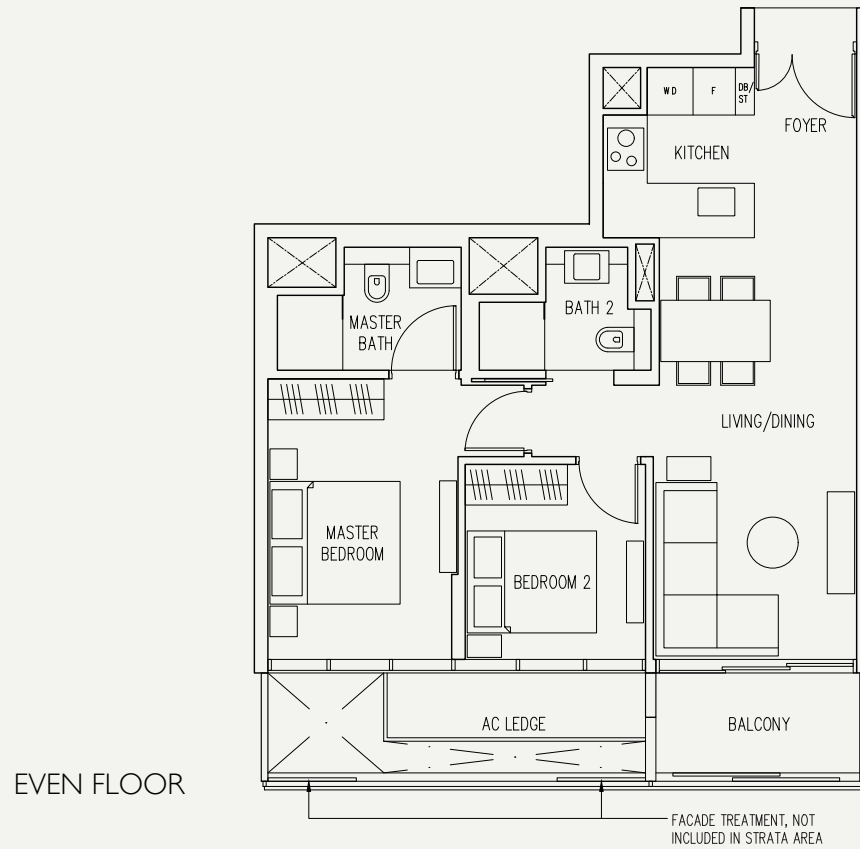
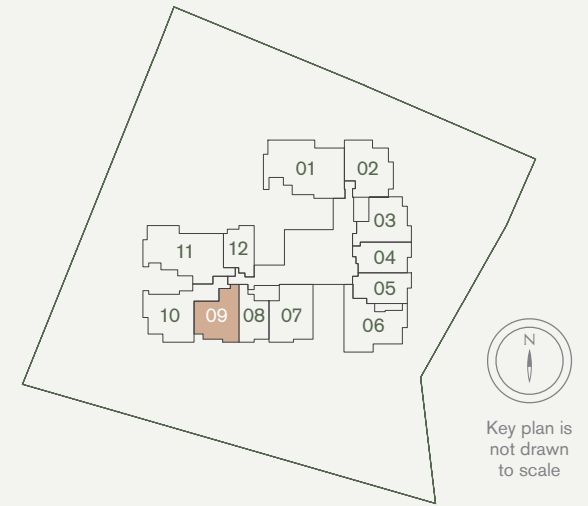

Area includes air-con (A/C) ledge, balcony and strata void area where applicable. Please refer to the key plan for orientation. The plans are subject to change as may be approved by relevant authorities. All floor plans are approximate measurements only and are subject to government re-survey. The balcony shall not be enclosed unless with the approved balcony screen. \*Denotes different ceiling height.



# 2-Bedroom

## Type B3

86 sqm / 926 sq ft  
#02-07 to #08-07, #09-07\*

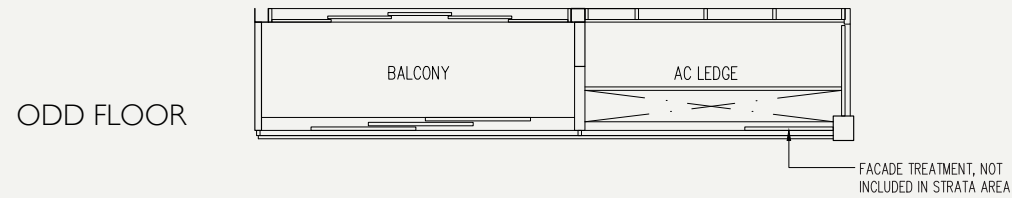
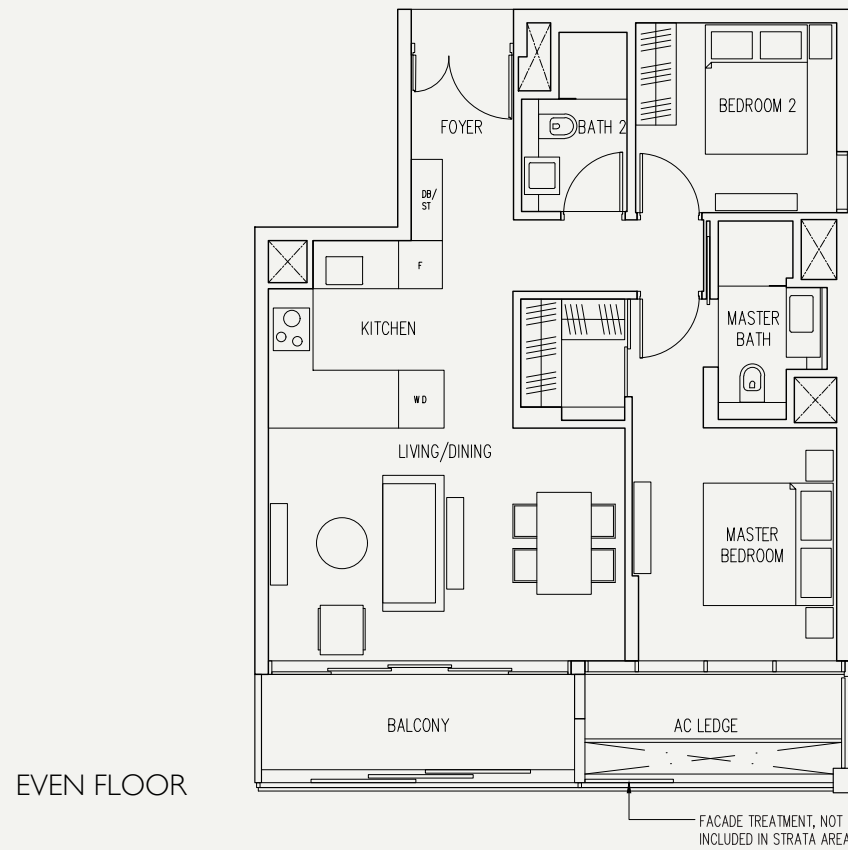
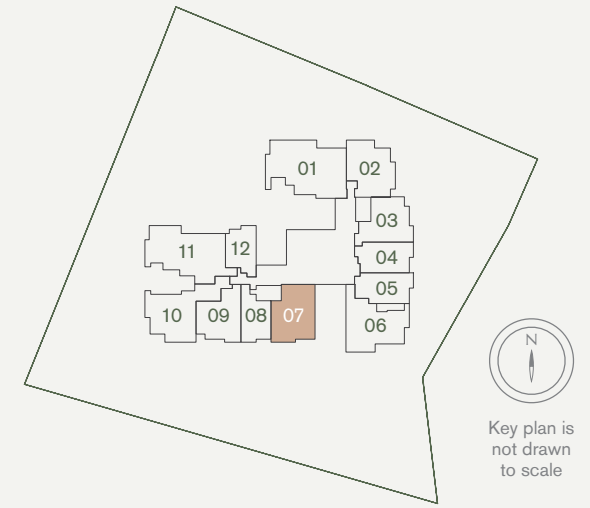

Area includes air-con (A/C) ledge, balcony and strata void area where applicable. Please refer to the key plan for orientation. The plans are subject to change as may be approved by relevant authorities. All floor plans are approximate measurements only and are subject to government re-survey. The balcony shall not be enclosed unless with the approved balcony screen. \*Denotes different ceiling height.



# 2-Bedroom + Study

Type BS1

98 sqm / 1,055 sq ft  
#02-06 to #09-06

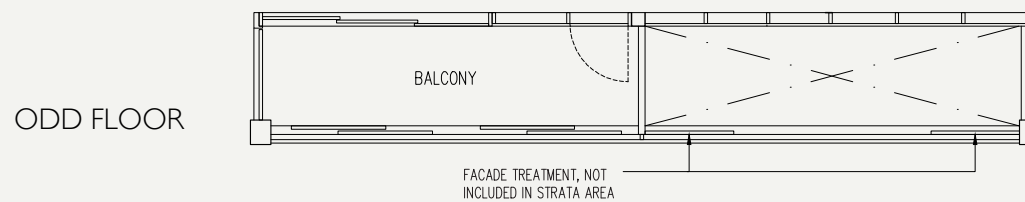
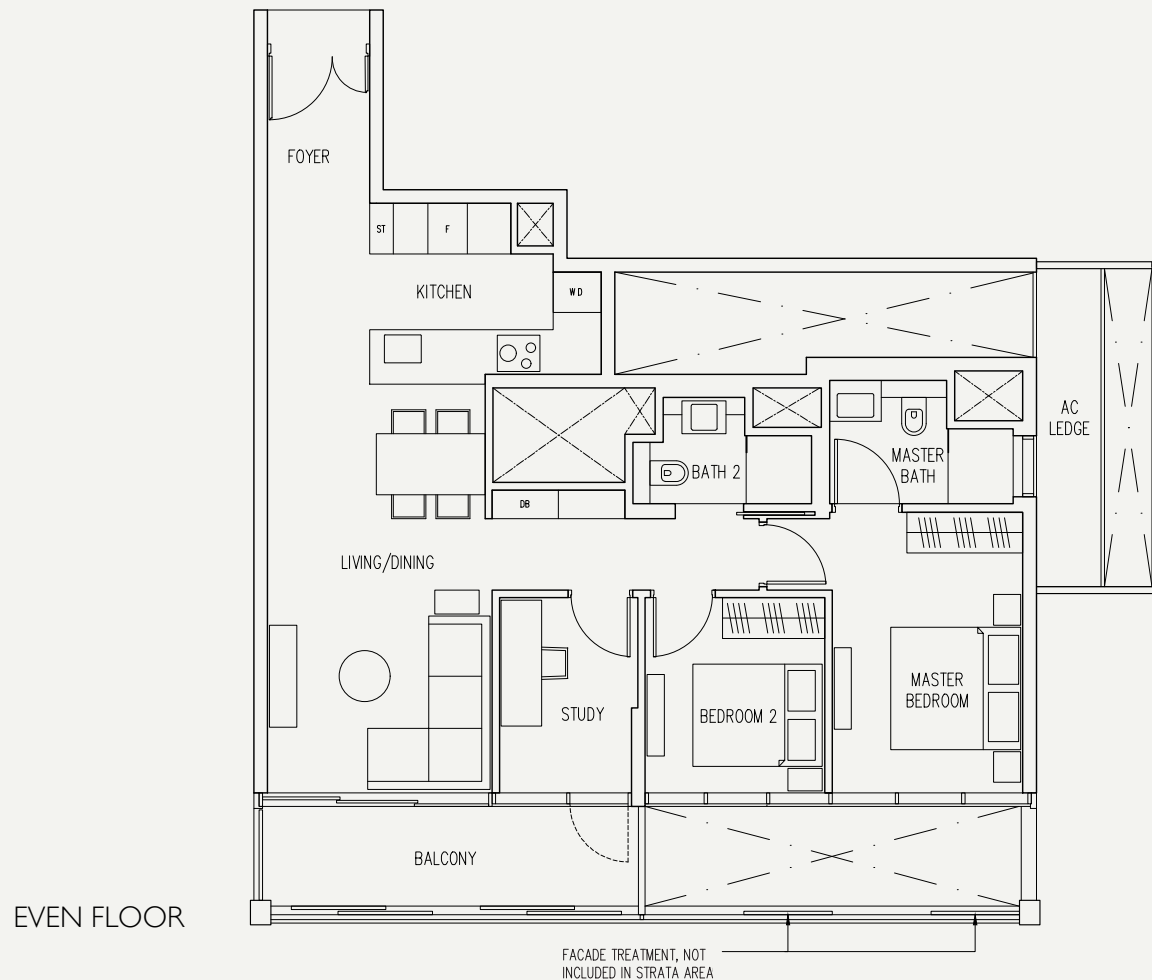
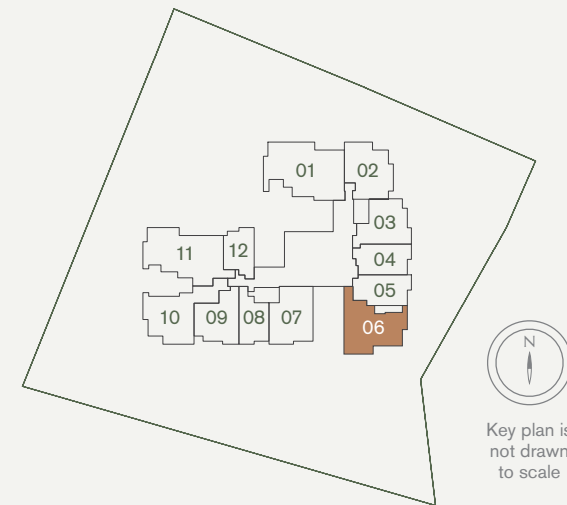

Area includes air-con (A/C) ledge, balcony and strata void area where applicable. Please refer to the key plan for orientation. The plans are subject to change as may be approved by relevant authorities. All floor plans are approximate measurements only and are subject to government re-survey. The balcony shall not be enclosed unless with the approved balcony screen. \*Denotes different ceiling height.



# 2-Bedroom Deluxe

Type B4

103 sqm / 1,109 sq ft  
#02-10 to #08-10, #09-10\*

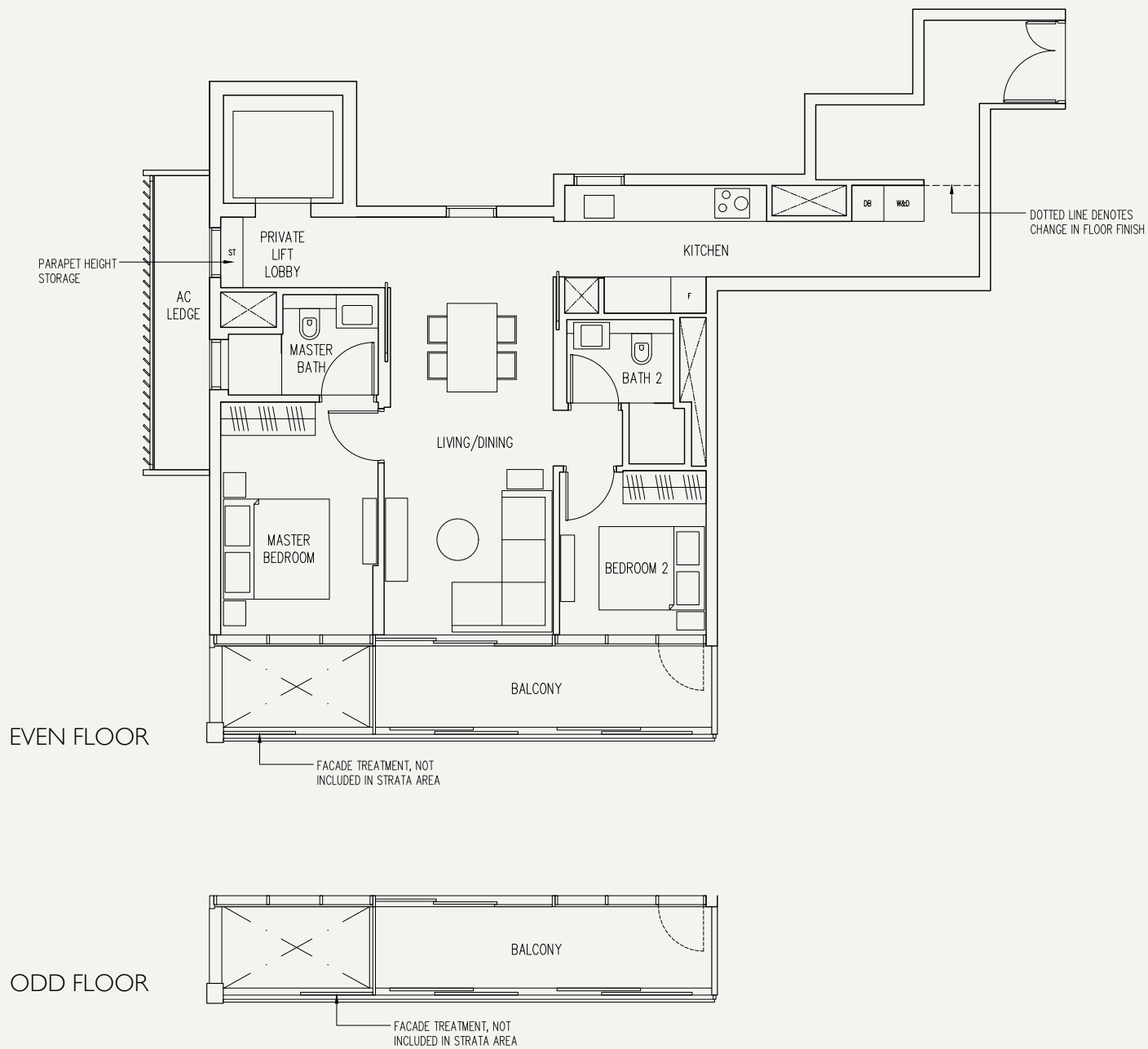
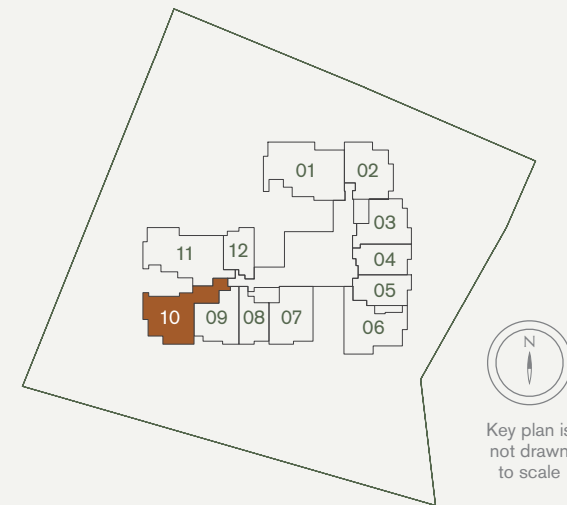

Area includes air-con (A/C) ledge, balcony and strata void area where applicable. Please refer to the key plan for orientation. The plans are subject to change as may be approved by relevant authorities. All floor plans are approximate measurements only and are subject to government re-survey. The balcony shall not be enclosed unless with the approved balcony screen. \*Denotes different ceiling height.



# 3-Bedroom Deluxe

Type C1

131 sqm / 1,410 sq ft  
#03-01, #05-01, #07-01, #09-01\*

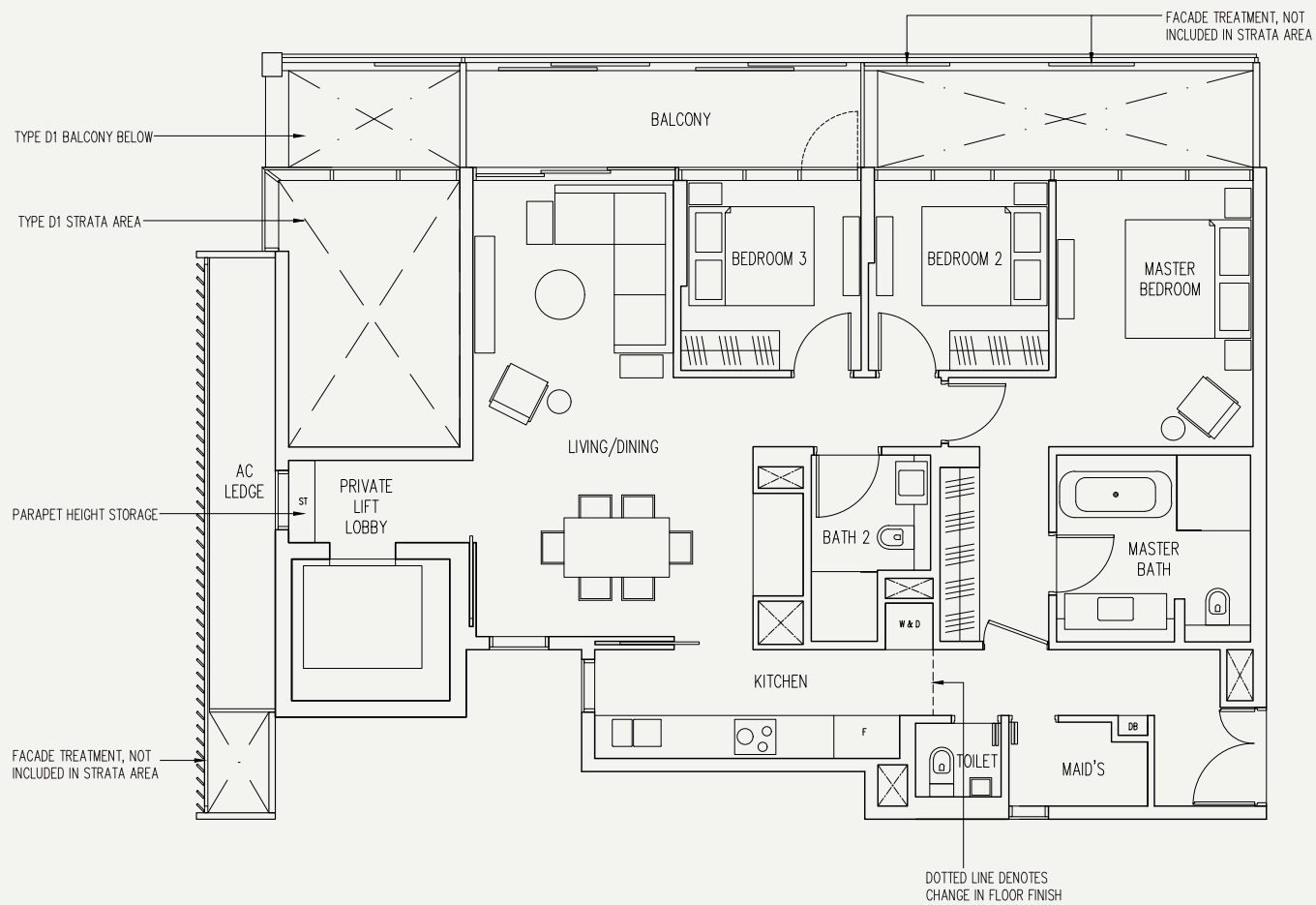
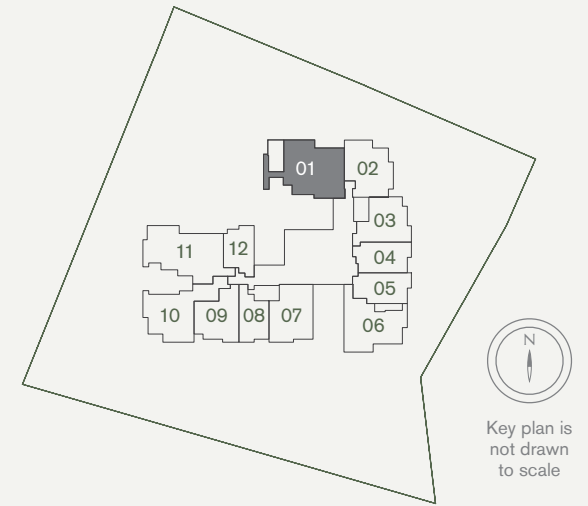

Area includes air-con (A/C) ledge, balcony and strata void area where applicable. Please refer to the key plan for orientation. The plans are subject to change as may be approved by relevant authorities. All floor plans are approximate measurements only and are subject to government re-survey. The balcony shall not be enclosed unless with the approved balcony screen. \*Denotes different ceiling height.



# 3-Bedroom Deluxe

**Type C2**

137 sqm / 1,475 sq ft  
 #02-11 to #08-11, #09-11\*, #10-11\*

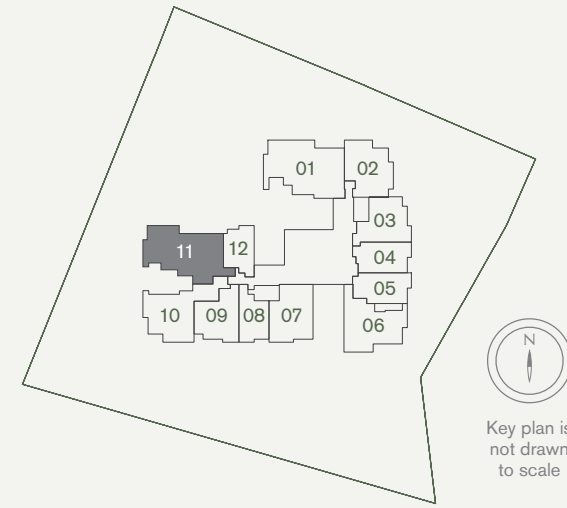

ODD FLOOR

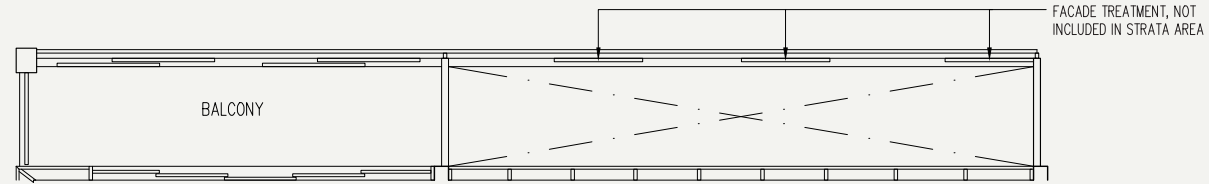

EVEN FLOOR

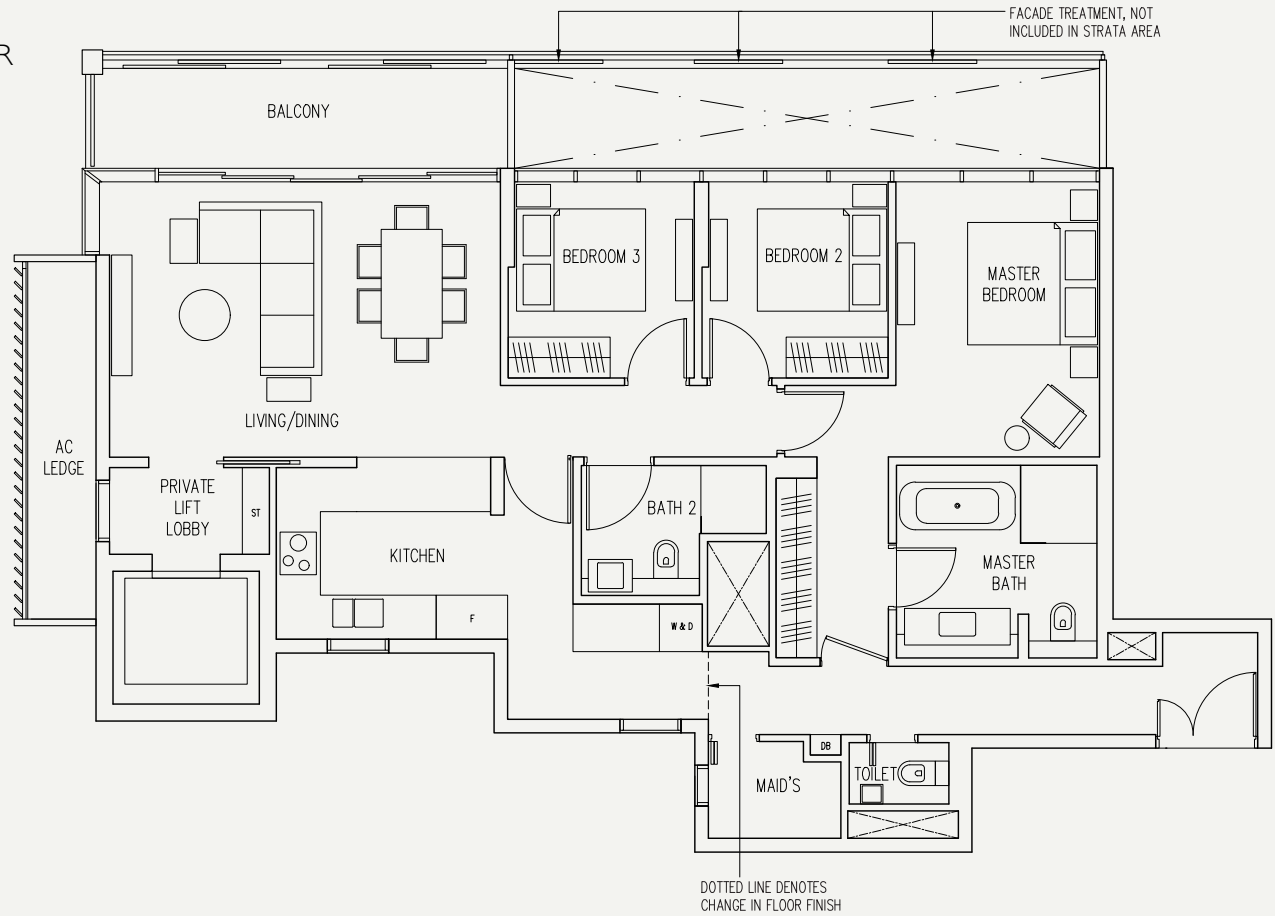

Area includes air-con (A/C) ledge, balcony and strata void area where applicable. Please refer to the key plan for orientation. The plans are subject to change as may be approved by relevant authorities. All floor plans are approximate measurements only and are subject to government re-survey. The balcony shall not be enclosed unless with the approved balcony screen. \*Denotes different ceiling height.



# 3-Bedroom Deluxe

Type C3

123 sqm / 1,324 sq ft  
#10-10

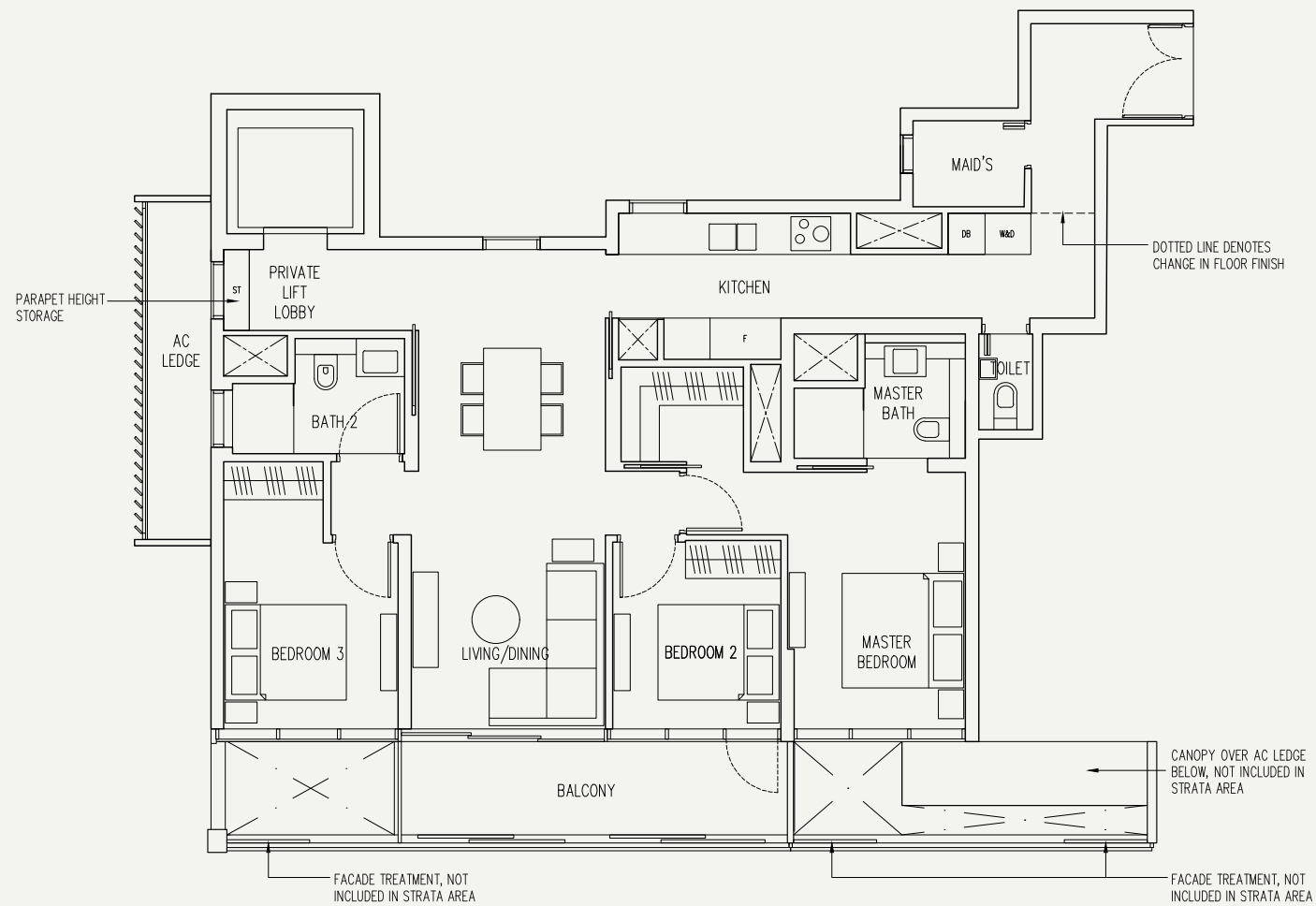
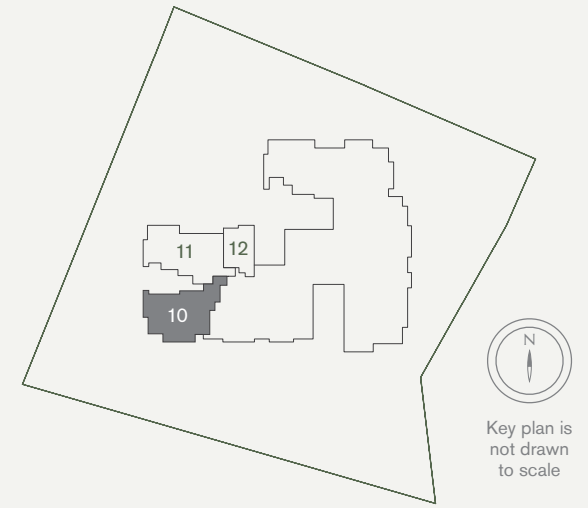

Area includes air-con (A/C) ledge, balcony and strata void area where applicable. Please refer to the key plan for orientation. The plans are subject to change as may be approved by relevant authorities. All floor plans are approximate measurements only and are subject to government re-survey. The balcony shall not be enclosed unless with the approved balcony screen. \*Denotes different ceiling height.



# 3-Bedroom Deluxe

Type D1(P) 170 sqm / 1,830 sq ft  
#01-01

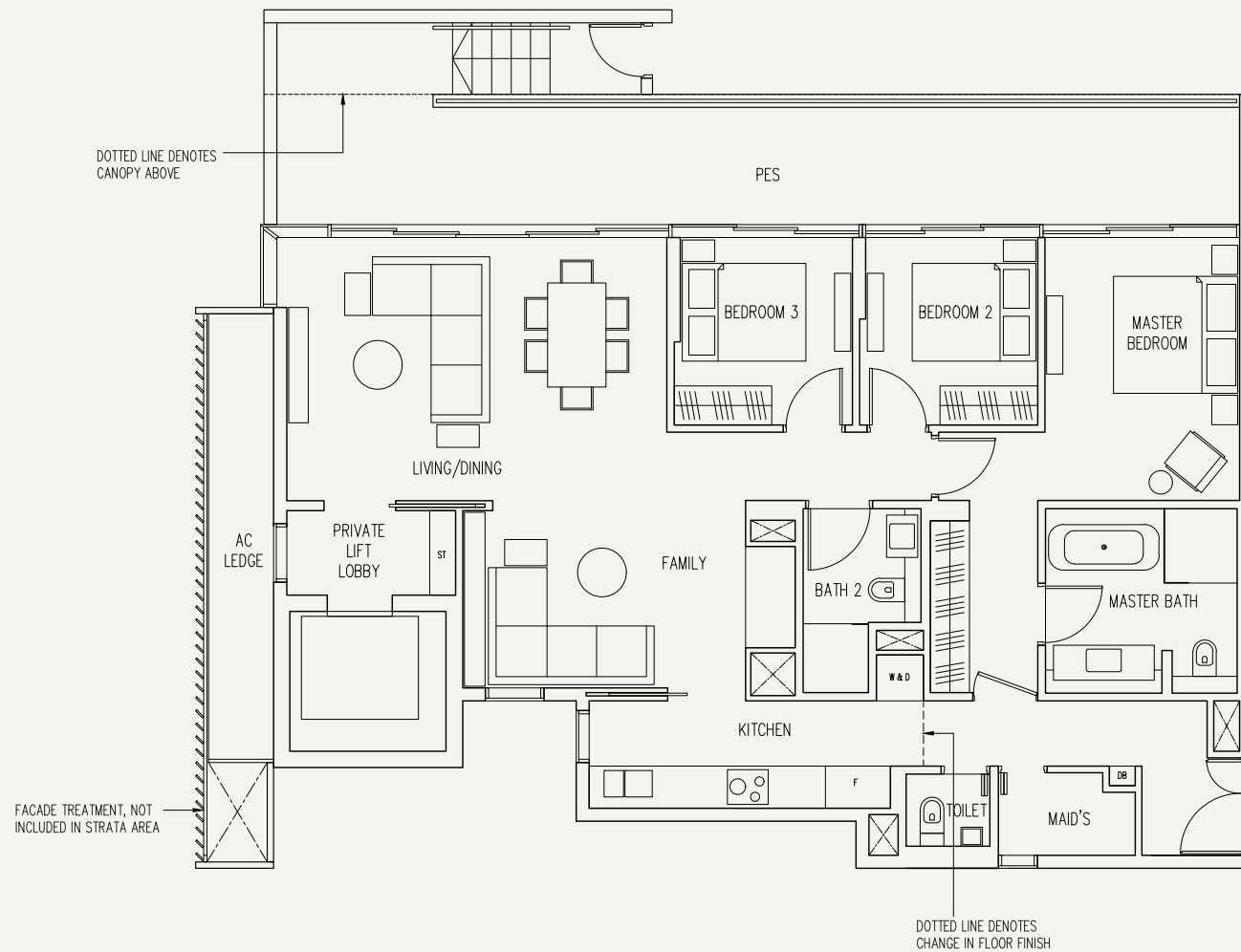
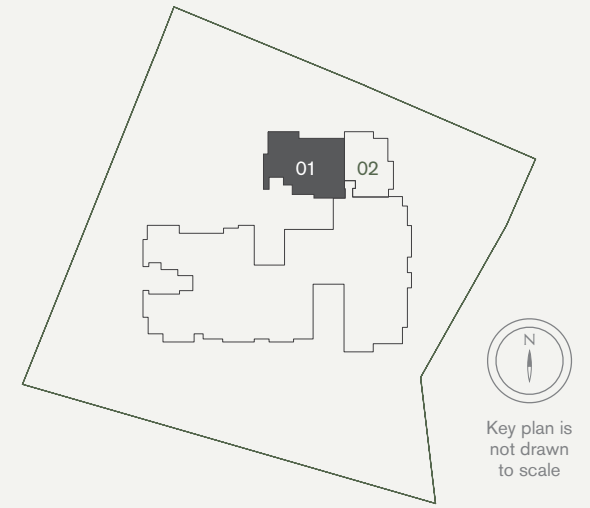

Area includes air-con (A/C) ledge, balcony and strata void area where applicable. Please refer to the key plan for orientation. The plans are subject to change as may be approved by relevant authorities. All floor plans are approximate measurements only and are subject to government re-survey. The balcony shall not be enclosed unless with the approved balcony screen. \*Denotes different ceiling height.



# 3-Bedroom Deluxe

**Type D1**

161 sqm / 1,733 sq ft  
 #02-01, #04-01, #06-01, #08-01\*

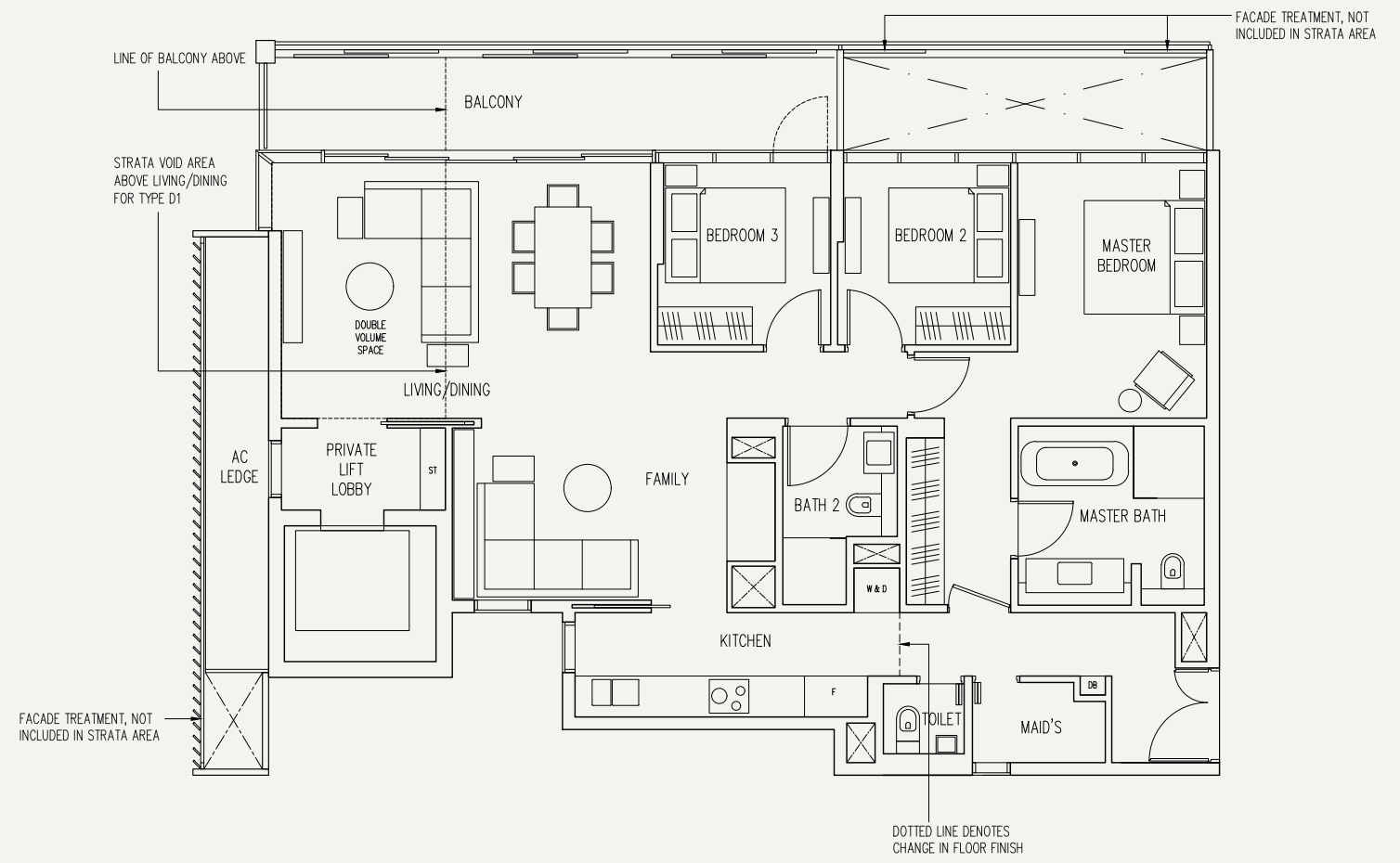
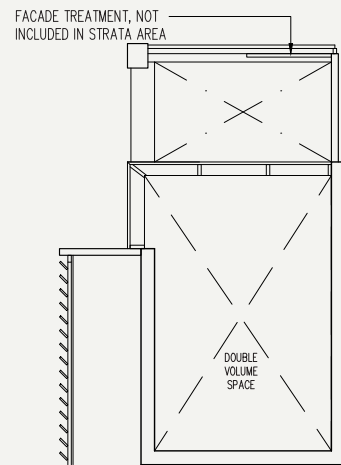
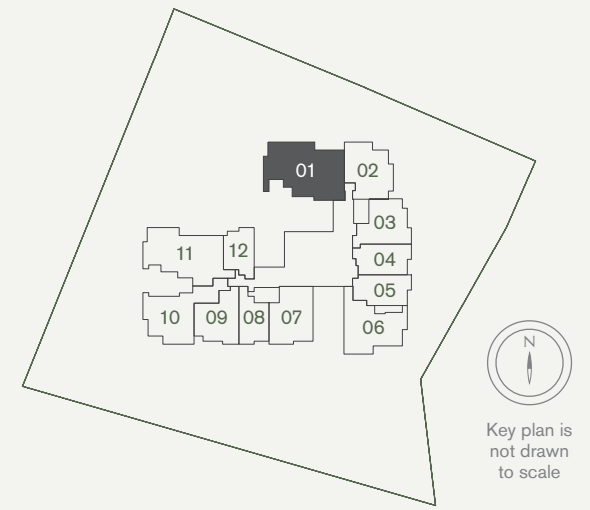

Area includes air-con (A/C) ledge, balcony and strata void area where applicable. Please refer to the key plan for orientation. The plans are subject to change as may be approved by relevant authorities. All floor plans are approximate measurements only and are subject to government re-survey. The balcony shall not be enclosed unless with the approved balcony screen. \*Denotes different ceiling height.



# An Architectural Gem by Keppel Land & SCDA



“The building is conceived as a floating volume with a continuous landscape plane that runs through. These volumes are articulated with specially profiled architectural screens that allow filtered sunlight into the interiors.”

**SOO K. CHAN**  
Founding Principal and Design Director  
of SCDA Architects Pte Ltd.

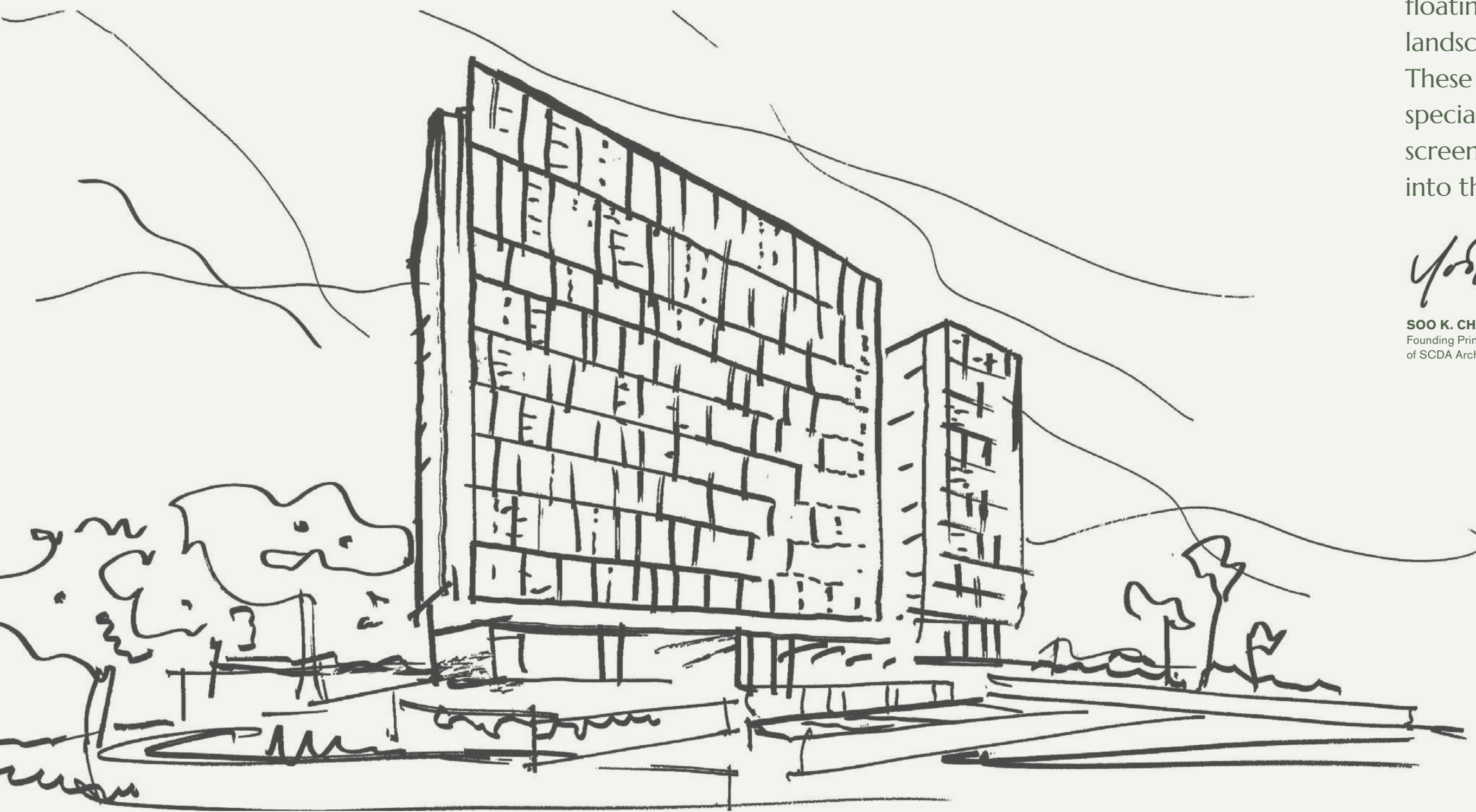

## An Acclaimed Celebrity Architect

Soo K. Chan is the Principal of SCDA Architects and an award-winning architect based in Singapore. He obtained his Master of Architecture degree from Yale University in 1987. Under his leadership, SCDA has grown to over 120 employees with offices in Singapore, Shanghai and New York.

Soo K. Chan's signature minimalist approach and transitional design blends the boundaries between indoors and outdoors making architecture at one with its natural surroundings.

His impeccable body of architectural work includes the Alila Villas Soori Bali, Indonesia, the Soori Niseko ski resort, Japan, the Soori Highline New York City, United States and now, 19 Nassim Hill.



# Keppel Land

Keppel Land is the property arm of Keppel Corporation, a multi-business company providing solutions for sustainable urbanisation.

As a multi-faceted property company, Keppel Land provides innovative real estate solutions with its sterling portfolio of award-winning residential developments, investment-grade commercial properties and integrated townships.

Keppel Land is geographically diversified in Asia, with Singapore, China and Vietnam as its key markets, while it continues to scale up in other markets such as Indonesia and India.



Reflections at Keppel Bay



Corals at Keppel Bay

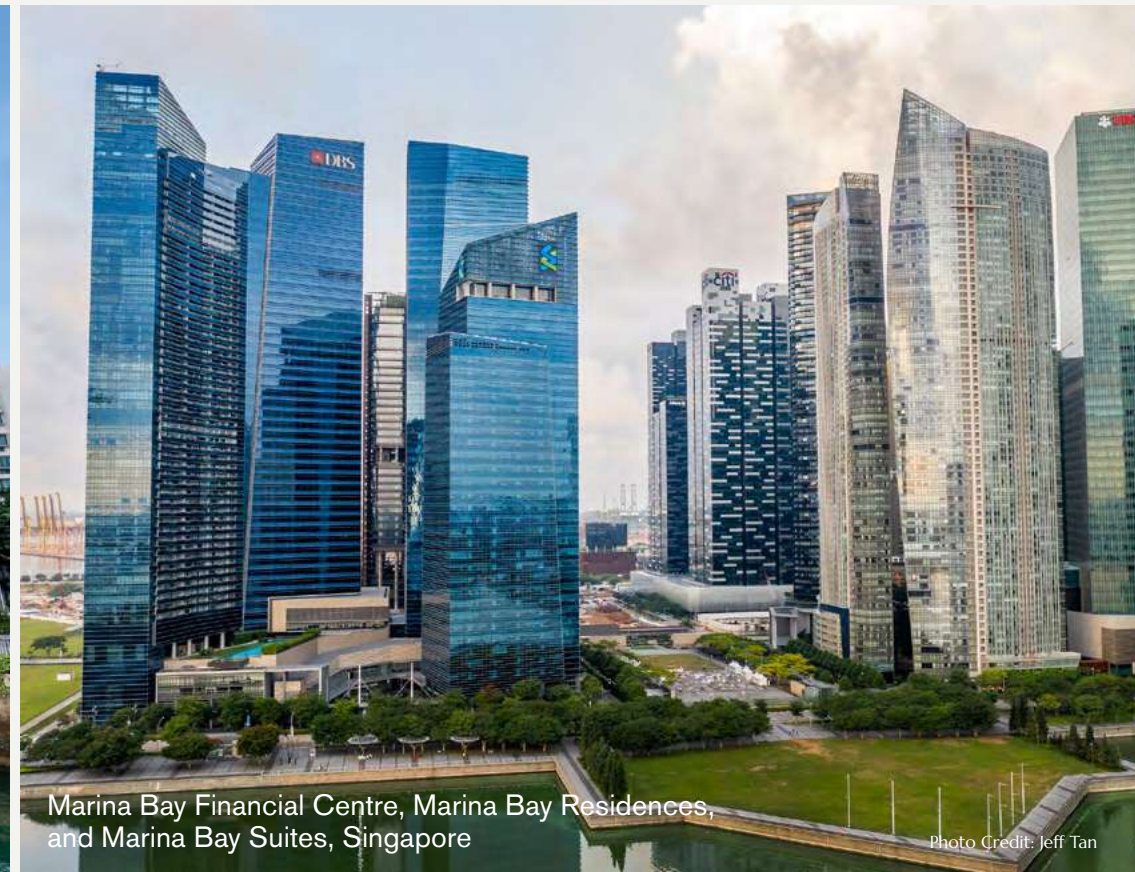

Marina Bay Financial Centre, Marina Bay Residences, and Marina Bay Suites, Singapore

Photo Credit: Jeff Tan



---

**Developer:** Parkville Development Pte Ltd.

**Developer License No.:** C1343.

**Tenure of Land:** 99 years (from 17/06/2019).

**Encumbrances:** Mortgage IF/875335F in favour of Standard Chartered Bank (Singapore) Limited

**Lot No.:** Lot(s) 01641P TS25 at 19 Nassim Hill.

**Expected Date of TOP:** 31/12/2023.

**Expected Date of Legal Completion:** 31/12/2026.

**Disclaimer:** The information contained in this brochure has been obtained from sources we believe to be reliable. However, the developer and its agents have not verified its accuracy and do not warrant the accuracy of the information in this brochure including the project website, model and the sales gallery/showflat (collectively, the "Materials") and the developer and its agents shall not be held responsible for any inaccuracies in their contents or any discrepancies between the Materials and the actual unit. All statements, literature and depictions in the Materials are not to be regarded or relied upon as statements or representations of fact, offers or warranties (whether expressly or impliedly) by us or our agents, and they are not intended to form part of any contract for any sale of the unit. In particular, visual representations such as layout plans, finishes, illustrations, pictures, photographs and drawings contained in the Materials are artists' impressions only and are not representation of fact. The Materials are for general guidance only and should not be relied upon as accurately describing any specific matter. All information, specifications, plans and visual representations contained in the Materials are current only as at the time of printing and are subject to changes from time to time by the developer and/or the competent authorities and shall not form part of the offer or contract. The Sale and Purchase Agreement shall form the entire agreement between the developer and the purchaser and shall in no way be modified by any statements, representations or promises (whether or not contained in the Materials and/or made by the developer or the agent). The floor plans are approximate measurements and are subject to final survey. All rights reserved.



**Keppel Land**